

TSSOP16

Outline Drawing (008-4964-16)

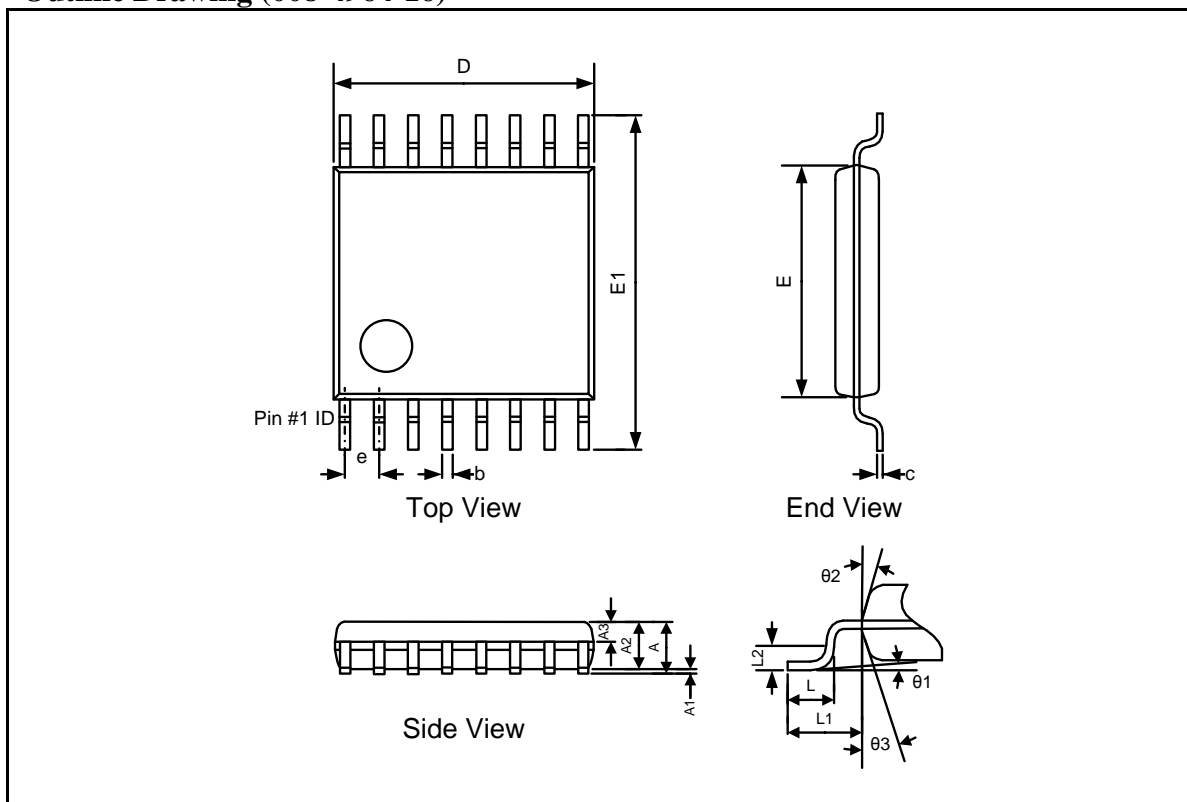

DIMENSIONS						
Symbol	MILLIMETERS			INCHES		
	Min	Typ	Max	Min	Typ	Max
A	-	-	1.20	-	-	0.047
A1	0.05	-	0.15	0.002	-	0.006
A2	0.80	-	1.05	0.031	-	0.041
A3	0.34	0.44	0.54	0.013	0.017	0.021
b	0.19	-	0.30	0.007	-	0.012
c	0.09	-	0.20	0.004	-	0.008
D	4.86	4.96	5.10	0.191	0.195	0.201
E	4.30	4.40	4.50	0.169	0.173	0.177
E1	6.20	6.40	6.60	0.244	0.252	0.260
e	0.65BSC			0.026BSC		
L	0.45	0.60	0.75	0.018	0.024	0.030
L1	1.00REF			0.039REF		
L2	0.25BSC			0.010BSC		
$\theta1$	0°	-	8°	0°	-	8°
$\theta2$	10°	12°	14°	10°	12°	14°
$\theta3$	10°	12°	14°	10°	12°	14°