

SOT89-5

Land Pattern (105-4545-05)

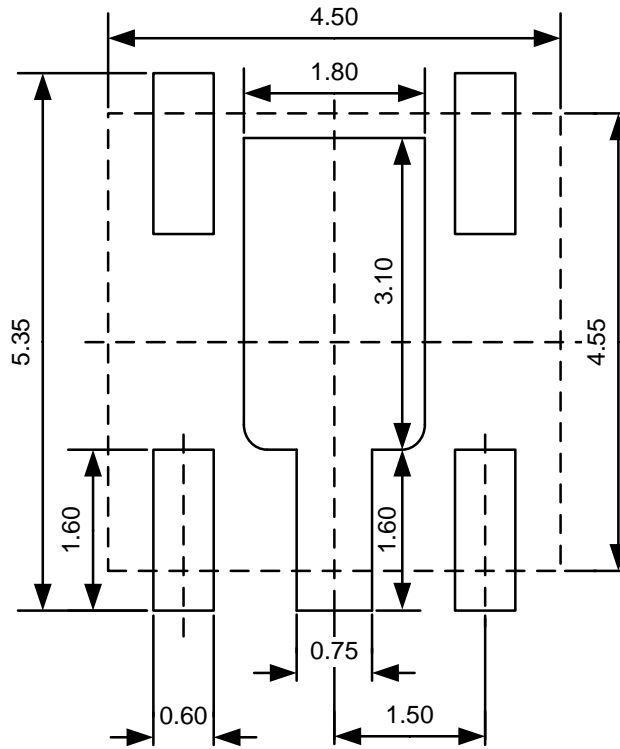

NOTES:

1. Compound dimension: 4.50×2.50.
2. Unit: mm.
3. General tolerance ± 0.05 mm unless otherwise specified.
4. The layout is just for reference.