

SOT23-3

Land Pattern (105-2928-03)

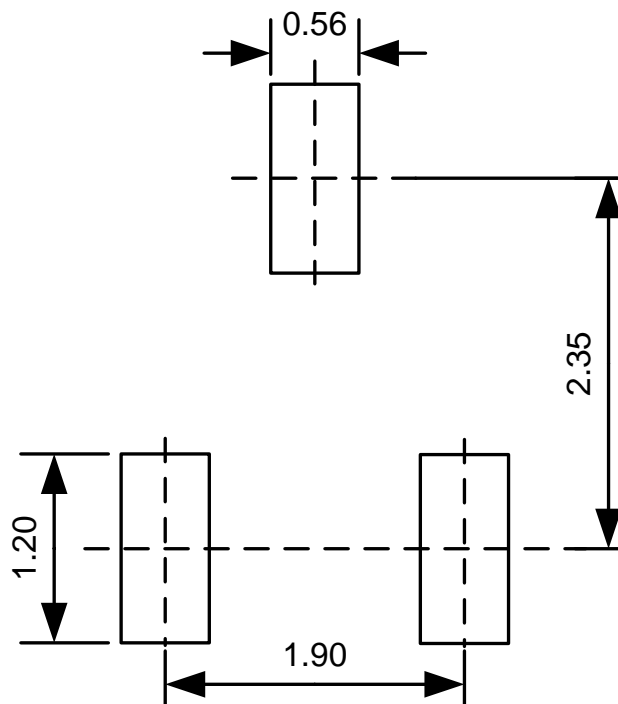

NOTES:

1. Compound dimension: 2.92×1.60.
2. Unit: mm.
3. General tolerance ± 0.05 mm unless otherwise specified.
4. The layout is just for reference.