

QFN12 2.0×2.0

Land Pattern (103-2020-12)

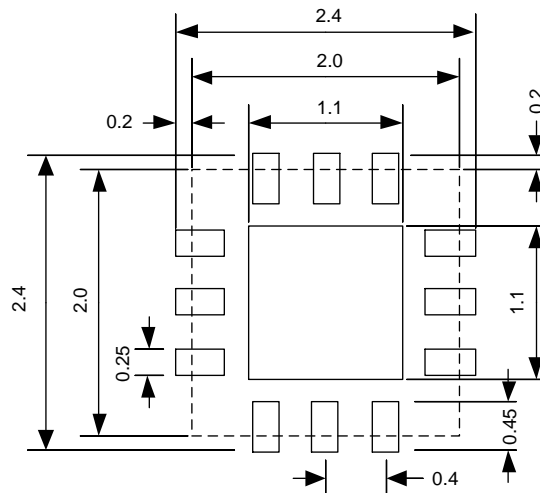

NOTES:

1. Compound dimension: 2.0×2.0 ;
2. Unit: mm;
3. General tolerance ± 0.05 mm unless otherwise specified;
4. The layout is just for reference.