

CSP20 2.7×2.4

Land Pattern (101-2724-20)

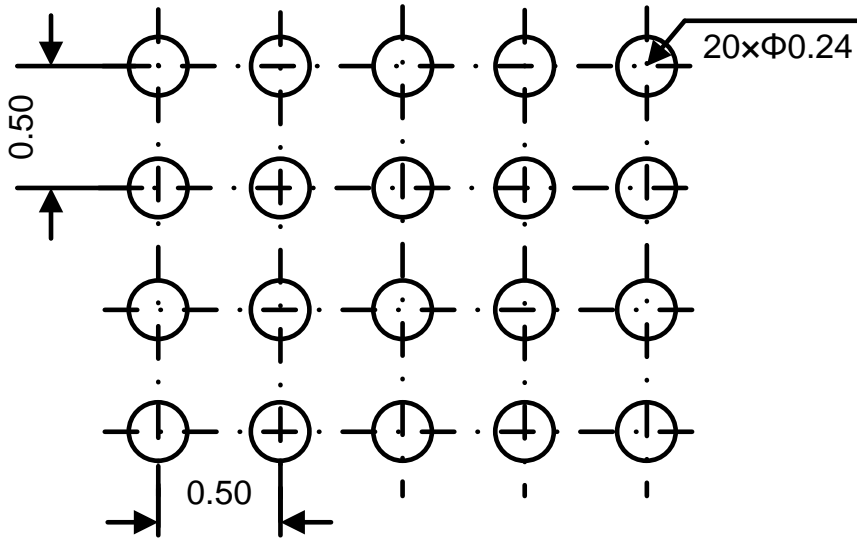

NOTES:

1. Bump is Lead Free Sn/Ag/Cu.
2. Unit: mm.
3. Non-solder mask defined copper landing pad.
4. Laser Mark on silicon die back; back-lapped.